

INSTRUCTIONS MANUAL

PTE-50-CET

THREE PHASE RELAY TEST SET

REFERENCE: FAGVMV02

EDITION: 5/11/99

VERSION: 2

“The priority of EUROSMC, S.A. is to obtain the highest standards and quality in all our products, serving to satisfy the expectations and necessities of our clients”.

INDEX

| | |
|--|----|
| PTE-50-CET CONTENTS LIST | 5 |
| 1. INTRODUCTION | 6 |
| 1.1. MAIN FUNCTIONAL FEATURES | 6 |
| 1.2. APPLICATIONS..... | 7 |
| 2. OPERATIONAL PRINCIPLES | 9 |
| 2.1. GENERAL..... | 9 |
| 2.2. FRONT PANEL CONTROLS | 10 |
| 2.3. INTELLIGENT GENERATOR MODULE | 11 |
| 2.4. POWER SUPPLY | 11 |
| 3. CONTROLS DESCRIPTION..... | 12 |
| 3.1. MAIN SUPPLY SECTION..... | 12 |
| 3.1.1. MAIN VOLTAGE SUPPLY | 12 |
| 3.1.2. FIXED 110 V c.a. VOLTAGE SUPPLY | 13 |
| 3.2. TIMER SECTION: CHRONOMETER..... | 13 |
| 3.2.1. CONTROL KEYS AND KNOBS: Selecting the function mode | 13 |
| 3.2.2. OPTIC INDICATORS AND DISPLAYS..... | 14 |
| 3.2.2.1. Function mode indication..... | 14 |
| 3.2.2.2. TIMER SIGNAL indicators..... | 15 |
| 3.2.2.3. Timer reading..... | 15 |
| 3.2.3. CONNECTORS: Monitor Signal..... | 15 |
| 3.3. POWER OUTPUTS | 16 |
| 3.3.1. LEVEL SECTION | 17 |
| 3.3.1.1. CONTROL KNOBS AND PRESS KEYS..... | 17 |
| 3.3.1.2. OPTICAL INDICATORS AND DISPLAYS..... | 19 |
| 3.3.1.3. TAPS: Output taps..... | 20 |
| 3.3.2. PHASE SECTION | 21 |
| 3.3.2.1. CONTROL KNOBS AND PRESS KEYS..... | 21 |
| 3.3.2.2. OPTICAL INDICATORS AND DISPLAYS..... | 23 |
| 3.4. CHANNELS IN PARALLEL | 24 |
| 3.4.1. USE | 24 |
| 3.4.2. CONNECTION | 24 |
| 3.4.3. EXAMPLE..... | 26 |
| 3.5. GENERAL CONTROL SECTION..... | 26 |

| | |
|--|----|
| 3.5.1. CONTROL KEYS | 27 |
| 3.5.1.1. Reset | 27 |
| 3.5.1.2. Print | 27 |
| 3.5.1.3. RS-232 serial port control..... | 27 |
| 3.5.1.4. SYNCHRONIZATION..... | 27 |
| 3.5.1.5. HARMONICS selection | 28 |
| 3.5.1.6. Activating the BOOSTER | 28 |
| 3.5.2. OPTIC INDICATORS | 28 |
| 3.5.2.1. RS-232 port indicator..... | 28 |
| 3.5.2.2. SYNCHRONIZING REFERENCE indicators..... | 29 |
| 3.5.2.3. Monitor state indicator | 29 |
| 3.5.3. CONNECTORS AND FUSES | 29 |
| 3.5.3.1. Voltage supply | 29 |
| 3.5.3.2. Monitor input taps | 30 |
| 3.5.3.3. Auxiliary output to start an external timer | 31 |
| 3.5.3.4. RS-232 connector..... | 31 |
| 4. FUNCTIONS: USE AND DESCRIPTIONS | 32 |
| 4.1. TIME MEASUREMENT | 32 |
| 4.1.1. SIGNAL MONITOR | 32 |
| 4.1.2. TIMER MODE SELECTION | 32 |
| 4.2. LEVEL SECTION: POWER OUTPUT | 33 |
| 4.2.1. INITIAL STATUS | 33 |
| 4.2.2. OUTPUT MODE SELECTION (I/V)..... | 33 |
| 4.2.3. OUTPUT RANGE SELECTION | 34 |
| 4.2.4. REFERENCE SOURCE SELECTION | 34 |
| 4.2.5. OUTPUT VALUES SELECTION..... | 34 |
| 4.2.6. OUTPUT CONTROL: ON/OFF AND ALARMS..... | 35 |
| 4.2.7. DYNAMIC TESTS: STEP TO 2 ND VALUE | 35 |
| 4.3. PHASE ANGLE SELECTION..... | 36 |
| 4.3.1. PHASE ANGLE SENSE | 36 |
| 4.3.2. DYNAMIC TESTS: STEP TO 2 ND VALUE | 37 |
| 4.3.3. USE OF EXTERNAL REFERENCE INPUT..... | 38 |
| 4.4. GENERAL CONTROL SECTION..... | 38 |
| 4.4.1. SIGNAL MONITOR | 38 |
| 4.5. COMMUNICATION IN BUS-PTE | 39 |
| 4.5.1. EVENTS IN BUS-PTE..... | 39 |
| 4.5.2. EVENT TRANSMITTED BY A PTE-50-CET..... | 39 |
| 4.6. SPECIAL FUNCTIONS..... | 40 |
| 4.6.1. AUTO OFF | 40 |
| 4.6.2. FAILURES DETECTION | 40 |

| | |
|---|----|
| 5. SPECIFICATIONS | 42 |
| 5.1. POWER GENERATORS | 42 |
| 5.2. INTERNAL TIMER | 43 |
| 5.3. HARMONICS GENERATOR | 43 |
| 5.4. EXTERNAL REFERENCE INPUT | 44 |
| 5.5. SIGNAL MONITORS | 44 |
| 5.6. AVAILABLE REFERENCES | 44 |
| 5.7. CONTAINER | 44 |
| 6. TECHNICAL ASSISTANCE, AFTER SALES SERVICE AND WARRANTY | 45 |
| 6.1. WARRANTY | 45 |
| 6.2. AFTER SALES SUPPORT | 45 |
| 6.3. OTHER EUROS MC PRODUCTS | 45 |

FIGURES INDEX

| | |
|--|----|
| Figure 1: <i>PTE-50-CET Front Panel</i> | 9 |
| Figure 2: <i>Functional Modules</i> | 9 |
| Figure 3: <i>Front Module</i> | 10 |
| Figure 4: <i>Intelligent Generator Module</i> | 11 |
| Figure 5: <i>Main Supply</i> | 12 |
| Figure 6: <i>Timer Section</i> | 13 |
| Figure 7: <i>Power Output</i> | 16 |
| Figure 8: <i>Level Output Selection</i> | 17 |
| Figure 9: <i>Phase Angle Selection</i> | 21 |
| Figure 10: <i>Channels Parallel Connection</i> | 25 |
| Figure 11: <i>General Control Sections</i> | 27 |
| Figure 12: <i>Fuses Box</i> | 30 |
| Figure 13: <i>Signal Monitor</i> | 31 |
| Figure 14: <i>Phase Angle Selection (European)</i> | 36 |
| Figure 15: <i>Phase Angle Selection (American)</i> | 37 |

PTE-50-CET CONTENTS LIST

- 1 Unit PTE-50-CET.
- 1 Nylon cover.
- 1 Voltage supply cable type Schuko.
- 12 Interconnection cables 2.5 mm² section (6 reds and 6 blacks).
- 1 Interconnection cable between PC and PTE-50-CET unit, by RS-232.
- 1 PTE BUS interconnection cable for two units.
- 1 Interconnection cable for external timer output PTE-50-CET type BNC.
- 4 Clips up to 50 A (2 reds and 2 blacks).
- 4 Clips up to 10 A (2 reds and 2 blacks).
- Replacement fuses:
 - 4 Fuses 5x20 100 mA, fast.
 - 4 Fuses 5x20 400 mA.
 - 2 Fuses 5x20 500 mA.
 - 4 Fuses 5x20 630 mA, fast.
 - 2 Fuses 5x20 2 A.
 - 4 Fuses 5x20 12 A, fast.
 - 4 Fuses 5x20 6.3 A, fast.
- 1 Case key.
- 1 Warranty.
- 1 Measurement Certificate.
- 1 Instructions Manual.
- Equipment with 220 V ac voltage supply:
 - 2 Fuses 5x20 6.3 A, included in the assembly switch ON/OFF.
- Equipment with 125 V ac voltage supply:
 - 2 Fuses 5x20 12 A, included in the assembly switch ON/OFF.

1. INTRODUCTION

The PTE-50-CET is designed as a **Portable Three Phase Unit** that allows the user to test, as stand alone unit or in combination with others, all type of protective relays.

Extremely compact and rugged, this unit incorporates the latest in the modern microprocessor technology to achieve unbeatable output characteristics in terms of power, accuracy, low distortion, and dynamic capability. This technology allows the unit to perform, without any external accessories, various specific functions very often used in the relay testing.

All the output signals are digitally generated, amplified and controlled by the internal IGMs (Intelligent Generation Modules) in terms of amplitude, phase and frequency. A high accuracy and stability are obtained in the output waveforms, which are absolutely independent of the main supply.

Contained in an aluminum IP-65 case, with a membrane keyboard that allows full manual control, and a RS-232 com port for computer control, the PTE-50-CET offers the best features actually available for on site manual or automatic relay testing.

1.1. MAIN FUNCTIONAL FEATURES

The following are the more outstanding functions/features that the PTE-50-CET has:

a) TIMER MEASUREMENT

Used when measuring the timing response of relays during test. The **digital timer** which is incorporated in the PTE-50-CET has a **resolution of 1 ms** and contains all the necessary controls to select the starting and stopping of the timer whether it is external or internal, or when using the monitor signal or via PTE-BUS.

b) AVAILABLE REFERENCES

The power output has **three different references** available:

- The main supply phase (*Line*).
- The PTE BUS (BUS).
- The *External Phase Reference* (current or voltage).

c) POWER OUTPUTS

The **current or voltage outputs** are available, **up to 50 A** in four ranges and **up to 150 V** in two ranges respectively.

Any power outputs combination is possible: two channels can work in voltage mode and the other one in current mode, or even all of them can work in voltage mode. In current mode, the unit allows channels parallel connection so it can supply up to $3 \times 50 \text{ A} = 150 \text{ A}$.

All the outputs have a **dynamic capability**. The output **regulation** can work **independently or linked in a three phase system**, when PTE units are working together interconnected through the PTE BUS, any combination of dynamic steps to 2nd values, can be selected in amplitudes and phase angles for any type of fault simulation.

d) EXTERNAL REFERENCES INPUT

Can be synchronized, in terms of frequency and phase with any external signal, **from 0.1 to 25 A** in current, and **from 5 to 300 V** in voltage.

e) SIGNAL MONITOR

The unit has a *Signal Monitor* input that can work with dry contacts or with voltage signals from 5 to 250 V ac or dc.

f) RS-232 COM PORT

Used to control the equipment from an external computer, can be used to perform the following:

- Software calibration.
- Automatic testing.
- Direct printing of the test results in a RS-232 input printer.

g) PTE BUS

Allows the interconnection with any other unit of the PTE RANGE.

h) EXTERNAL TIMER CONTROL OUTPUT

Delivers a pulse signal, dry contact type, of 20 ms duration. This can be used to start an external timer, for timing measurements. This signal is produced every time one of the power outputs changes its status, or the *Step* key is activated in amplitude or in phase.

i) OUTPUT PROTECTION

The outputs and, in general, the unit, are electronically protected against overload, short-circuit and over temperature. These alarms are indicated on the *Front Panel*.

Standard 5 x 20 mm fuses protect the rest of inputs and general devices included in the unit.

1.2. APPLICATIONS

a) AS STAND ALONE TESTING UNIT

- Synchronizing relays.
- Multifunction generator protection Relays.
- Harmonics relays.
- Overcurrent relays (up to 150 A).
- Inverse time overcurrent relays.
- Definite time overcurrent relays.
- Earth and neutral (including harmonics filtering).
- Voltage controlled relays.
- Directional relays.
- Differential relays.

- Single phase distance relays.
- Directional power relays (single and three phase).
- Maximum and minimum voltage relays.
- Dynamic test. Fault simulation.

b) COMBINED WITH A SINGLE PHASE CURRENT INJECTOR

- Three phase distance relays.
- Full three-phase network fault simulation.
- In general all types of relays which require 3 voltages and 3 currents to function correctly.

c) MISCELLANEOUS

Due to its good characteristics of accuracy and stability, the PTE-50-CET can test transducers, energy meters and measuring instruments can be tested as well, in the following range:

- Three phase current up to 50 A (or 150 A single phase).
- Voltage in three-phase or single phase (up to 150 V).
- Harmonic selection, independent en each channel, up to the 5th harmonic.
- Three-phase angle from 0° to 359.9°.

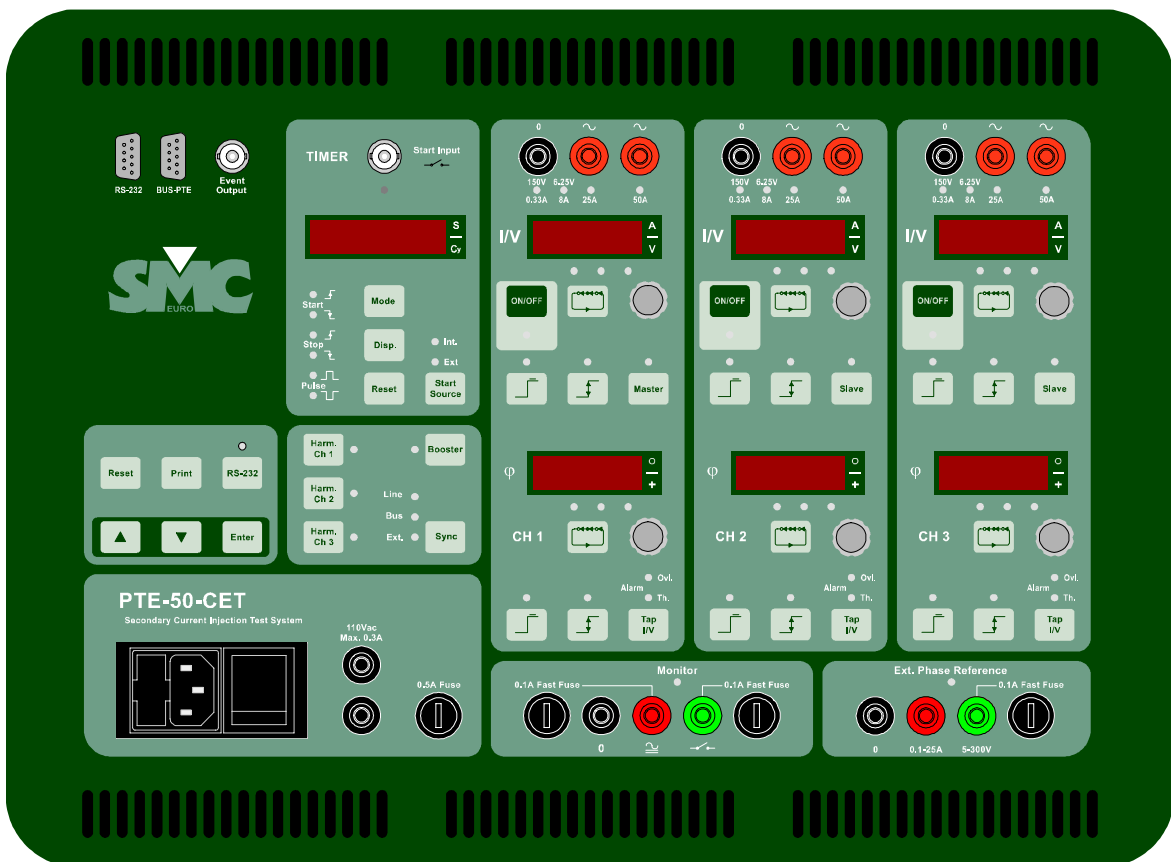

Figure 1: PTE-50-CET Front Panel

2. OPERATIONAL PRINCIPLES

2.1. GENERAL

In this section a general overview of the operational basic principles on which the PTE-50-CET is based, are given in this section. An understanding of these principles should help in order to find new applications, maintenance, etc.

Briefly, the unit has a user interface (Front Panel), that is communicated with the *Power Amplifier* through the microprocessors incorporated. Of course, a power supply, security devices, transformers, etc. need to be used as well. According with these, the unit can be divided in the following modules:

1. *Front Panel Controls.*
2. *Intelligent Generator Modules (IGM).*
3. *Power Supply.*

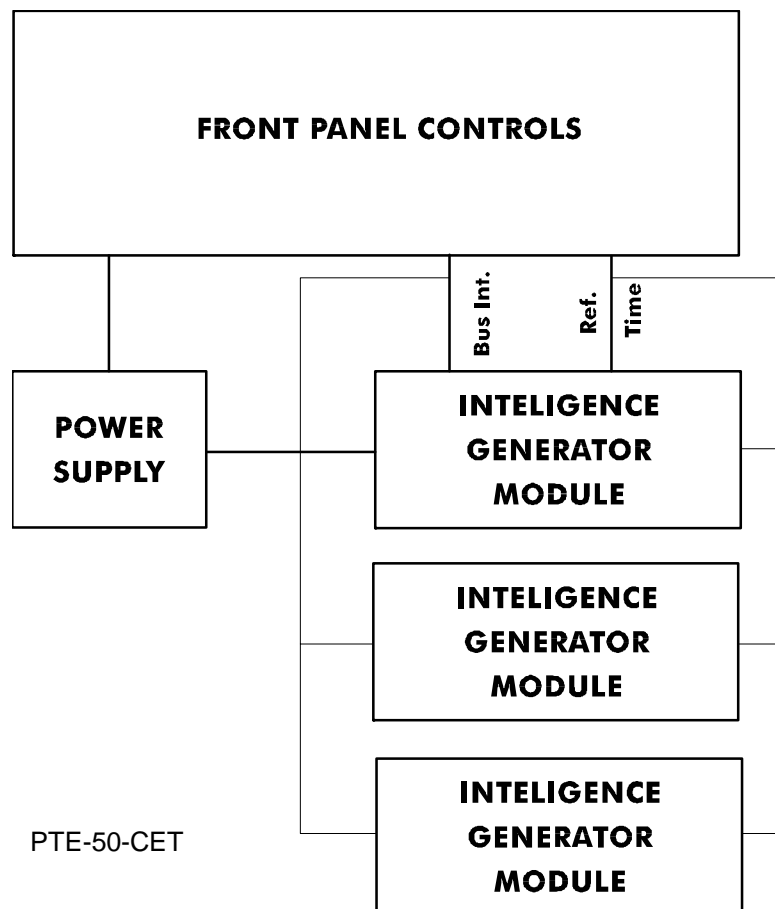

Figure 2: Functional Modules

2.2. FRONT PANEL CONTROLS

Allows the user to communicate with the power output section of the unit in a manual way, or using a software program. To achieve this, it has the following sections:

1. **Displays and LED indicators:** indicate the various selections made by the operator and the status of the unit.
2. **Press key controls:** this is a membrane keyboard with acoustic feedback, in which the various different functions available in the unit are selected.
3. **Multi-turn control knobs:** these are rotative pulse generators that are used to make the different selections desired on the displays indicators, in an easy and fast manner.
4. **Monitor taps:** contain the circuits to detect the status of the signals applied in these taps.

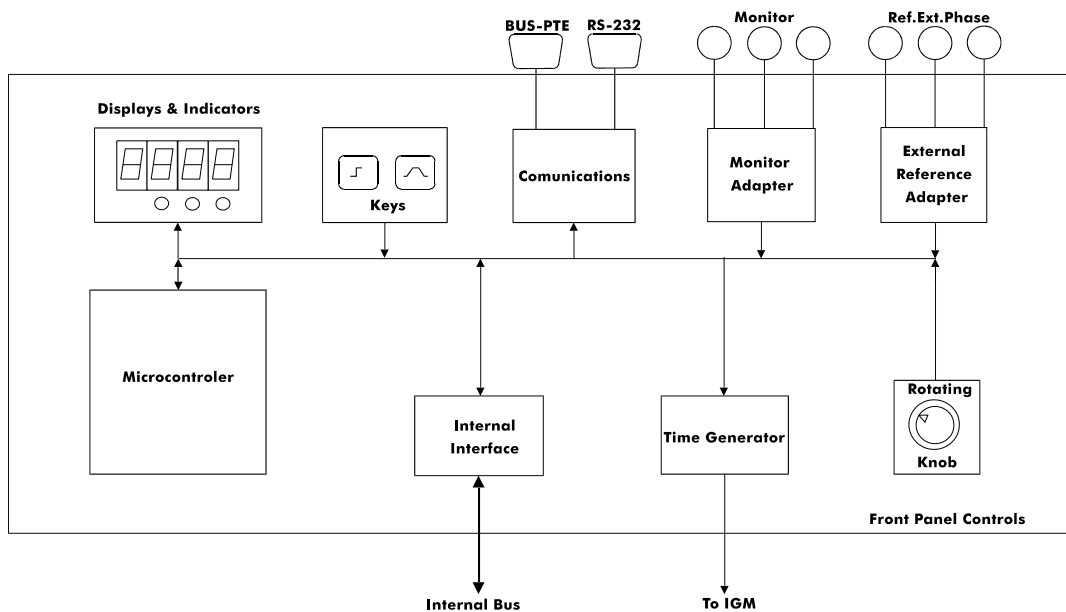

Figure 3: *Front Module*

5. **External Reference Taps:** contain the circuits to synchronize the power outputs to the phase and frequency signals connected to these taps.
6. **Communications:** the PTE units have the capability to communicate with some external control devices by RS-232 (allowing the user for printing results and calibration from the PC) and by BUS-PTE, for interconnection with PTE RANGE units and control of these by a PC.
7. **Internal Bus Interface:** establishes the communication between the *Front Panel* and the *Intelligent Generator Module*, via the microprocessors included in both.
8. **Time Generator:** it generates the high accuracy time reference necessary to generate the internal phase and frequency.
9. **Output taps:** these are the taps of the auxiliary voltage supply of 110 V ac, the power output taps, and the tap to start an external timer.

10. **Microcontroller:** it is one of the most important parts of the unit, which as its name indicates, controls or establishes the flow of information between all the functional blocks previously mentioned.

2.3. INTELLIGENT GENERATOR MODULE

Essentially, the IGM is a linear power amplifier, controlled by its internal microprocessor. It produces the sinusoidal signal in the frequency and the phase selected. This is amplified and adapted by a transformer in the selected output range. This generator also feeds back the output level in voltage, current, and phase, to the generation stage, thus achieving a high accuracy output.

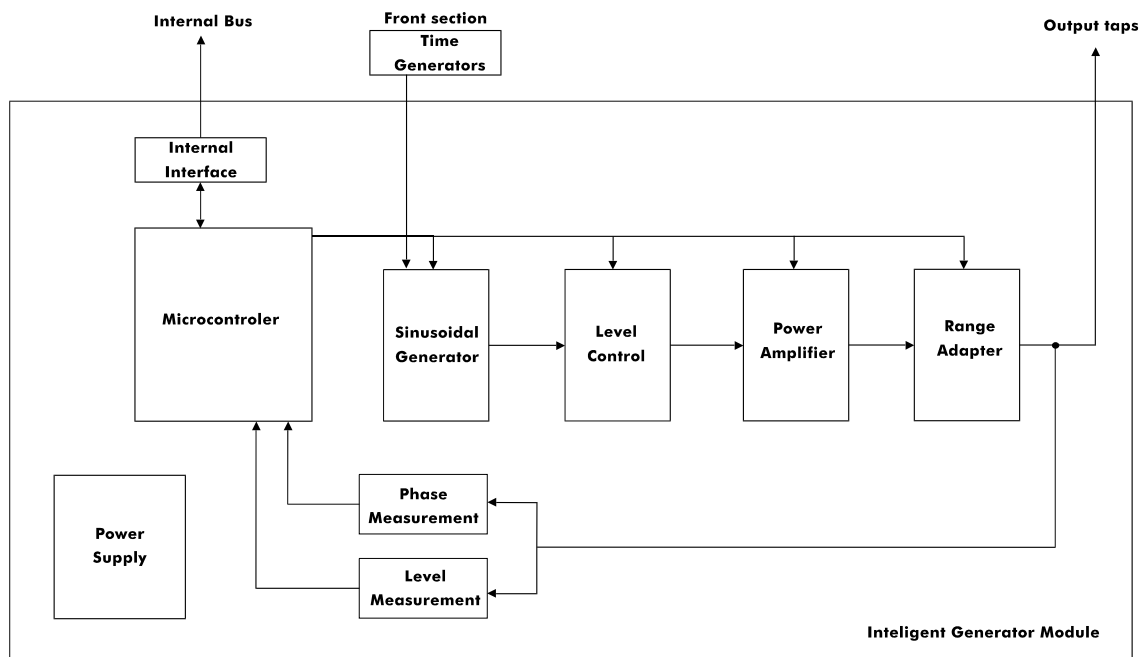

Figure 4: *Intelligent Generator Module*

As shown in the block drawing and in the front panel control functions, a microprocessor is in charge of supervising all the functions of the generator modules. These receive the output measurements and make the corrections necessary in amplitude and phase to obtain the desired accuracy. Also they store the calibration parameters, and use them to correct the selections made from the *Front Panel*.

2.4. POWER SUPPLY

As in all off the systems that produce an output which is absolutely independent of the main supply, the PTE-50-CET needs to have a D.C. power supply, that converts the AC input of the main supply, to a DC that supplies the power amplifiers. This is achieved by using a combination of switching and linear DC power supplies.

3. CONTROLS DESCRIPTION

This section describes one by one and in detail all of the controls, indicators, displays, and connection taps on the front panel of the PTE-50-CET. As well as the functions, marked indications and where they are located will be shown in the figures.

To understand this clearly, sections will describe the controls, by their functions, and by their physical position on the front panel. The different types of controls that you can find are classified as follows:

- **KEY CONTROLS:** this refers to the press key and rotating knobs.
- **DISPLAY AND OPTIC INDICATORS:** this refers to the LED indicators and the selection displays.
- **CONNECTORS (TAPS):** this refers to all taps (input and output), connectors, etc., which are contained in the PTE-50-CET. This section describes all the connectors that are incorporated in the unit. All of them meet international safety standards and are easily identified with their corresponding identification marks on the front panel.

3.1. MAIN SUPPLY SECTION

3.1.1. MAIN VOLTAGE SUPPLY

The unit is supplied with SCHUKO type plug 2 poles with earth. Also incorporated in the connector is a filter to avoid perturbations from the main supply.

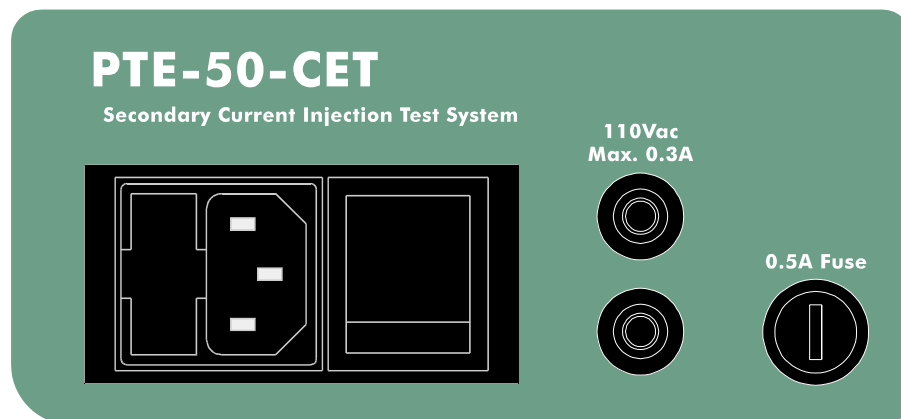
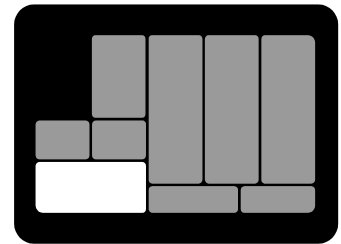
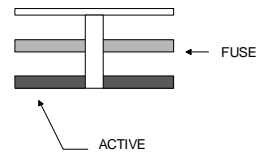

Figure 5: *Main Supply*

This is situated on the bottom left hand side of the unit and includes the following:

- Power supply with 2 poles and earth.

- Power supply fuse holder: to reach these fuses, the cover must be lifted as indicated in the drawing. There are two fuses: the lower one is the active fuse and the one located above is the spare fuse. The fuses are standard type, 5 x 20 mm, 6.3 A..
- Power supply switch: it has 2 positions, ON/OFF. The unit is disconnected when the red mark of the switch is visible.



3.1.2. FIXED 110 V c.a. VOLTAGE SUPPLY

This output is located in the lower central section to the right of the power supply switch. It consists of 2 black taps.

This output is always active when the unit is switched on. The taps have a distance of 19 mm which is the standard two-pole plug size.

3.2. TIMER SECTION: CHRONOMETER

The *Timer* is located on the left-hand side of the unit and clearly marked from the rest of the unit. It contains all the necessary controls for various timing functions, which are explained below.

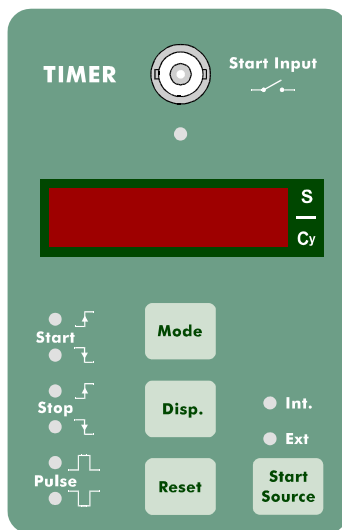
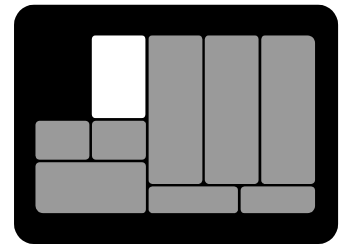

Figure 6: *Timer Section*

3.2.1. CONTROL KEYS AND KNOBS: Selecting the function mode

This section describes how to select the timer mode for the starting/stopping of the timer, the timer reading, and how to reset it. The keyboard for the timer is as follows:



This key works in a sequential way, that is to say by pressing this key; the LEDs will indicate the different selection combinations. There are different possibilities to choose from, see 3.2.2.1.

Disp.

This key works in a sequential way, each time this key is pressed, the reading in *Display 1* located on the left-hand side will change. This will display seconds or the number of frequency cycles in alternating current.

Reset

Each time this key is pressed the timer will reset to 0, allowing the operator to perform the next test. If the timer is not reset, all the outputs and displays will remain on hold and blocked.

Start Source

This key allows the selection of the *Timer* whether it is internal or external. Each time this key is pressed the selection will change from one to another. There are 2 optic LEDs associated with this key.

3.2.2. OPTIC INDICATORS AND DISPLAYS

3.2.2.1. Function mode indication

There are 6 green LEDs of 3 mm. When these are lit they indicate mode function the equipment has. These LEDs are associated with the *Mode* key.

a) START Mode indicators



These 2 LEDs indicate the start mode of the *Timer* in relation to the output control ON/OFF and to the *2nd Value Step* press key. These 2 LEDs are 3 mm and green. Only one can be used at the same time.

When the upper LED is lit, it indicates that the *Timer* will start when the output control is activated (ON) or when there is a *Step to 2nd Value*. When this LED is flashing it indicates that the *Timer* is in BUS mode, meaning that it will start when there is a positive event in the BUS.

When the lower LED is lit, it indicates that the *Timer* will start when the output control is deactivated (OFF) or when a *Step to 2nd Value* is deactivated. When this LED is flashing it indicates that the *Timer* is in BUS mode, meaning that it will start when there is a negative event in the BUS.

b) STOP Mode indicators



These 2 LEDs indicate the stop mode of the *Timer* in relation to the *Monitor* state. These 2 LEDs are 3 mm and green. Only one can be active at the same time.

When the upper LED is lit, it indicates that the *Timer* will stop when the *Signal Monitor* is activated. When this LED is flashing it indicates that the *Timer* is in BUS mode, meaning that the *Timer* will stop when there is a positive event in the BUS.

When the lower LED is lit, it indicates that the *Timer* will stop when the *Signal Monitor* is deactivated. When this LED is flashing it indicates that the *Timer* is in BUS mode, meaning that the *Timer* will stop when there is a negative event in the BUS.

The *MODE* key exclusively controls them.

c) PULSE Mode indicators

 These 2 LEDs indicate the *Timer* is in the PULSE MEASUREMENT MODE, and whether the pulse is positive or negative. These pulses are measured through the *Signal Monitor* taps.

These 2 LEDs are green and 3 mm. Only one can be active at the same time.

When the upper LED is lit, it indicates the *Timer* will read an active or positive pulse measurement.

When the lower LED is lit, it indicates the *Timer* will read a non-active or negative pulse measurement.

Both of these LEDs are controlled by the *Mode* key and can only be active when the *Timer* is in the EXTERNAL Mode.

3.2.2.2. TIMER SIGNAL indicators

- **Int.** These are two green and 3mm LEDs. Only one can be active at the same time. When the **Int.** LED is lit, the timer will start /stop with internal signals from the unit, such as:
 - Activating ON/OFF in any channel.
 - Activating a *Step to 2nd Value* in any channel.
- **Ext**

When the EXT LED is lit, the start signals are produced externally, and introduced in the *Monitor 2* located above the *Timer* display. At the same time the *Timer* should be set in the PULSE mode in *Monitor 1*.

3.2.2.3. Timer reading



The timer reading has 5 digit, 7 segment LEDs and 0.3 inches in height. There are two possible readings:

- **S:** time in SECONDS.
- **Cy:** NUMBER OF FREQUENCY CYCLES IN ALTERNATING CURRENT.

The *Timer* display can only make 1 stop and start event, and cannot be used again until the *Reset* key is pressed.

3.2.3. CONNECTORS: Monitor Signal



Start Input

This BNC connector is associated with a 3 mm, yellow LED. This input allows only a dry contact, voltage free. When the input is closed the LED will light up indicating the *Monitor* is active.

- In the *Manual Mode* this input is used to start the timer from an external signal.

3.3. POWER OUTPUTS

The equipment has three output and phase channels. In each one of them can be selected the desired output level as well as the phase angle.

This section is situated in the central section of the unit, and is clearly identified. All the controls, indicators, etc. contained in this part of the unit will be explained.

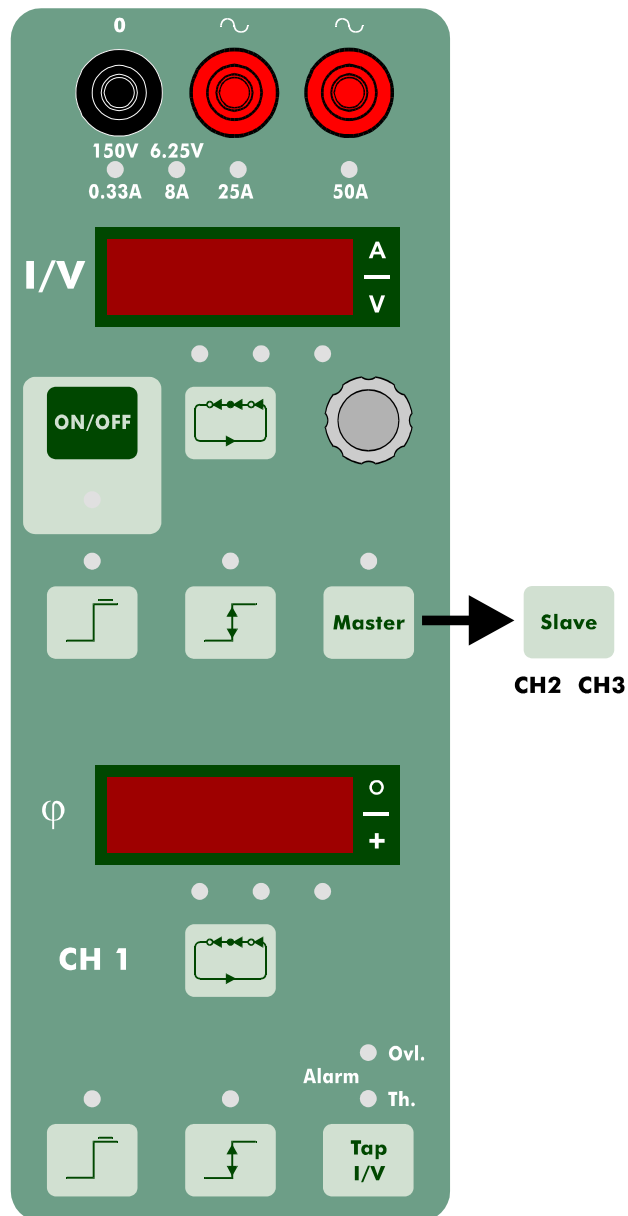
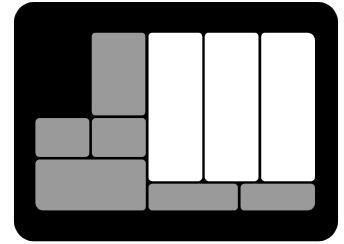

Figure 7: Power Output

3.3.1. LEVEL SECTION

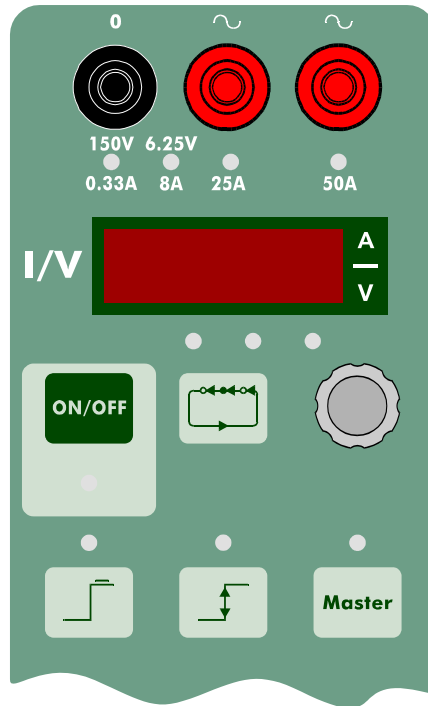

Figure 8: Level Output Selection

3.3.1.1. CONTROL KNOBS AND PRESS KEYS

a) Selecting the digit to be used



This key works in a sequential way and it is associated with 3 LEDs located above this press key. This allows the operator to select the output in a fine or course regulation, by changing the digit to be adjusted.

The following resolutions can be obtained:

- 1 digit.
- 10 digits.
- 100 digits.

When pressing this key for more than 2 seconds, it will block the rotating pulse generator, not allowing any modifications to the level selected.

b) Rotating control knob



This is a rotating pulse generator and has step by step sensation. The values can be increased or decreased by turning this control knob clockwise or anti-clockwise by one digit per step, according to the selected digit weight as described previously.

This knob has no end and can be controlled at any speed. However if the control knob is turned very fast the value will change at a maximum rate of 1 digit per second.

c) Output ON/OFF selection



When this key is pressed the output will turn on and the LED situated below will light up.

When it is pressed again it will disconnect this output and the LED will be off.

d) 2nd value selection



When this key is pressed it allows the selection of a 2nd value and it is shown in the display. This selection does not cancel the value already selected in the output at the moment. To distinguish the actual value from the 2nd value selected, the LED over the key lit when the 2nd value is displayed.

e) Activating 2nd value



This key works in a sequential way. When pressed the output value changes to the 2nd value, when it is pressed again it will return to the 1st value.

When this key and the similar key in the phase section are pressed at the same time for more than 2 seconds this function if both sections becomes synchronized. To cancel you must repeat this process.

f) MASTER/SLAVE: regulation modes

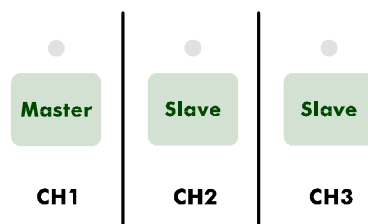

The following press keys are installed on the PTE-50-CET to achieve regulation capability in terms of three-phase regulation, fault combinations, like a phase to phase, three-phase, etc.

- Output channel 1 (CH1): MASTER key.
- Output channel 2 (CH2): SLAVE key.
- Output channel 3 (CH3): SLAVE key.

When no key is activated, the output channels are completely independent in all their functions.

When the MASTER key of CH1 is activated, at least one slave must be activated also. The MASTER function affects all channels in SLAVE mode (CH1, CH2 or both) as follows:

- Any output value change made in CH1, through the rotating knob in level or phase angle, occurs immediately in the SLAVE channels.
- If the output mode (voltage or current) is changed in CH1, it changes immediately in the SLAVE channels.

- If the output range is changed in CH1, it changes immediately in the SLAVE channels.
- Any action made in the output control ON/OFF in CH1 occurs immediately in the SLAVE channels.
- Any action made in the *Step to 2nd Value* control in CH1 happens immediately in the SLAVE channel.
- The only operation made in CH1 that is not immediately reflected in the SLAVE channels is the *2nd Value Selection* that must be activated channel by channel in any case.
- The SLAVE channels remain independent in terms of control. It means that any action made in a SLAVE channel only affects itself.

3.3.1.2. OPTICAL INDICATORS AND DISPLAYS

a) LED indicator for 2nd value selection

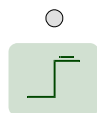

This is a 3 mm, red LED that is situated over the corresponding key. When this LED is lit, it indicates that it is in the *2nd Value Selection* mode and that this value is shown in the display.

b) LED indicator when 2nd value is activated

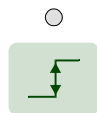

This is a 3 mm, red LED that is situated over its corresponding press key. It has two states:

- Not lit: indicates that the value in the output is the first value.
- Lit: indicates that the value has changed to the second value.

c) ON/OFF LED indicator



This is a 3 mm, red LED that is situated below the corresponding press key. It has two states:

- Not lit: indicates that there is no output (OFF).
- Lit: indicates that the output is on (ON).
- Not lit: indicates that there is no output (OFF).

This indicator shows the OUTPUT ACTUAL STATE. It can be either internally controlled by the unit (for instance, *Overload Alarm*).

d) Digit selection indicator

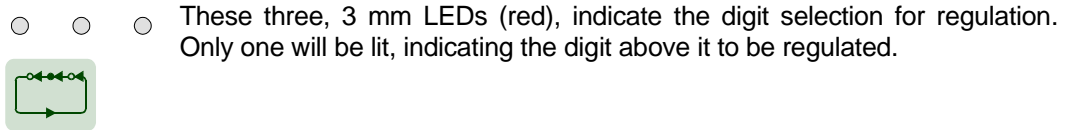

e) Level selection display



The display is made up of 4 digits of 7 segments, red in color and 0.3 inches in height, which shows the selected values and the corresponding units to the selected parameter with three lightning indicators located to the right side of the display.

There are two different parameters available:

- current (A).
- voltage (V).

In current and voltage, depending on the selected range, the decimal point will adjust automatically. The V and A indicators will light up automatically when selected.

When the value in the display begins to flash, it indicates that the value selected and is not in the output.

f) Output range selection indicators

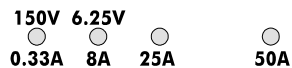

They are four red LEDs of 3 mm located below the output taps. These indicate the selected output range, in voltage or current.

These ranges are selected by pressing the *TAP I/V* key.

3.3.1.3. TAPS: Output taps

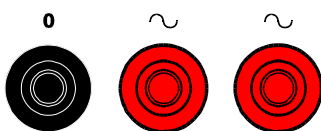

These taps are situated in the upper central part of the unit and consist of 3, 4 mm female connectors up to 50 A. The first ones are used for the voltage and current outputs and the third one is used only for current, in the 50 A range. With the unit two testing cables are supplied, which are used with these taps.

3.3.2. PHASE SECTION

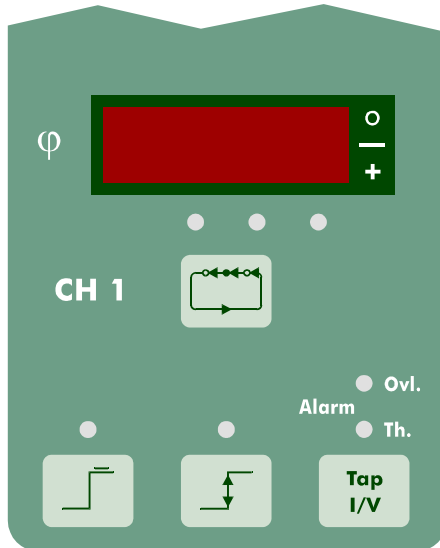

This is situated to the right of the unit and is perfectly identified. It contains all the control knobs, keys, and LEDs necessary for the operator to use the functions in this section.

Figure 9: *Phase Angle Selection*

3.3.2.1. CONTROL KNOBS AND PRESS KEYS

a) Selecting the digit to be used



This key works in a sequential way and it is associated with 3 LEDs located above this press key. This allows the operator to select the output in a fine or course regulation, by changing the digit to be adjusted.

The following resolutions can be obtained:

- 1 digit.
- 10 digits.
- 100 digits.

When pressing this key for more than 2 seconds, it will block the rotating pulse generator, not allowing any modifications to the phase angle selected.

b) Rotating control knob



This is a rotating pulse generator and has step by step sensation. The values can be increased or decreased by turning this control knob clockwise or anti-clockwise by one digit per step, according to the selected digit weight as described previously. This knob has no end and can be controlled at any speed.

However if the control knob is turned very fast the value will change at a maximum rate of 1 digit per second.

c) 2nd value selection



When this key is pressed it allows the selection of a 2nd phase angle and it is shown in the display. This selection does not cancel the angle already selected in the output at the moment. To distinguish the actual angle from the 2nd value selected, the LED over the key lit when the 2nd value is displayed.

d) Activating 2nd value



This key works in a sequential way. When pressed the phase angle in the output changes to the 2nd value, when it is pressed again it will return to the 1st value.

When this key and the similar key in the phase section are pressed at the same time for more than 2 seconds this function if both sections becomes synchronized. To cancel you must repeat this process.

e) Output range and output type selection



This key has two function modes:

1. Selection of the output type: this key serves to select the output type desired, that is voltage (V) or current (I). When turning on the unit it will be in current output. To change this output to voltage you must press this key for more than 2 seconds. To change this output back to current, repeat the process.
2. Output range selection: this key also serves to select the output range, in voltage and current. This key works in a sequential way: each time it is pressed it will change the output range. There are 2 ranges in voltage and 4 ranges in current. They are:
 - Current:
 - 0 - 0.33 A
 - 0 - 8 A
 - 0 - 25 A
 - 0 - 50 A
 - Voltage:
 - 0 - 6.25 V
 - 0 - 150 V

This key is associated with the 4 red LEDs with the ranges marked and the display in this section.

3.3.2.2. OPTICAL INDICATORS AND DISPLAYS

a) LED indicator for 2nd value selection

- This is a 3 mm, red LED that is situated over the corresponding key. When this LED is lit, it indicates that it is in the 2nd Value Selection mode and that this value is shown in the display.
- 

b) LED indicator when 2nd value is activated

- This is a 3 mm, red LED that is situated over its corresponding press key. It has two states:
- 
- Not lit: indicates that the phase angle in the output is the first value.
 - Lit: indicates that the phase angle in the output has changed to the second value.

c) Alarm indicators

- There are two, 3 mm LEDs (red) which indicate the status of the two alarms for the output of PTE-50-CET. They are as follows:
- Alarm
- Ovl.
 - Th.

1. Ovl: this LED indicates an overload in the output, whether it is current or voltage. When it is lit, the output will cut off and the display will begin to flash for 5 seconds. During this time it is possible to reset the output by pressing the ON/OFF button.
2. Th: this LED indicates an internal thermal overload, (temperature overload). When this alarm is on, the LED will light up, and the output will cut off. While this LED is on it is not possible to work with the unit and the operator must wait until the internal temperature lows.

NOTE: When the thermal alarm is lit, turn off the unit for at least 1/2 hour.

d) Digit selection indicator

- ○ ○ These three, 3 mm LEDs (red), indicate the digit selection for regulation. Only one will be lit and it indicates the digit above it to be regulated.



e) Phase selection displays



The display is made up of 4 digits of 7 segments, red in color and 0.3 inches in height, which shows the selected values.

3.4. CHANNELS IN PARALLEL

3.4.1. USE

When the channels are connected in parallel, we are actually looking for **more power** than only one channel can give, not always for higher current.

We must realize that one output channel, of PTE-50-CET, can supply 100 VA as maximum. This means that for each output tap we have a voltage value that cannot be exceeded:

| Tap | Maximum voltage |
|---------------------|-----------------|
| 0.33 A | 150 V |
| 8 A Booster OFF | 6.25 V |
| Booster ON | 12.5 V |
| 25 A Booster OFF | 2 V |
| Booster ON | 4 V |
| 50 A Booster OFF | 1 V |
| Booster ON | 2 V |

In fact, the only electrical parameter with a real physical sense, by itself, is voltage. We cannot define a current supply in terms of current capacity only, but we need to define the maximum load that can be connected to the taps, to reach the current limit.

Suppose we have the burden of a relay (15 VA) at the nominal current (5 A). We can calculate its internal impedance using the *Ohm's Law*:

$$VA_{LOAD} = I_{LOAD} \times V_{LOAD} \Rightarrow V_{LOAD} = VA_{LOAD} / I_{LOAD} = 15/5 = 3 \text{ V}$$

$$Z_{LOAD} = V_{LOAD} / I_{LOAD} = 3/5 = 0.6 \text{ A}$$

This means that if you want to inject 5 A in this relay a 3 V voltage is needed, so a 15 VA power from the injection equipment.

If you select the 25 A tap (Booster ON), on PTE-50-CET, you can inject this current to the relay, because $3V < 4V$ (maximum voltage drop). Instead, if we select the 50 A tap, you can't get sufficient voltage ($3V > 2V$), so the test can't be performed.

3.4.2. CONNECTION

If we want the channels of PTE-50-CET, to work in parallel, it is necessary that the outputs are connected in the way shown below:

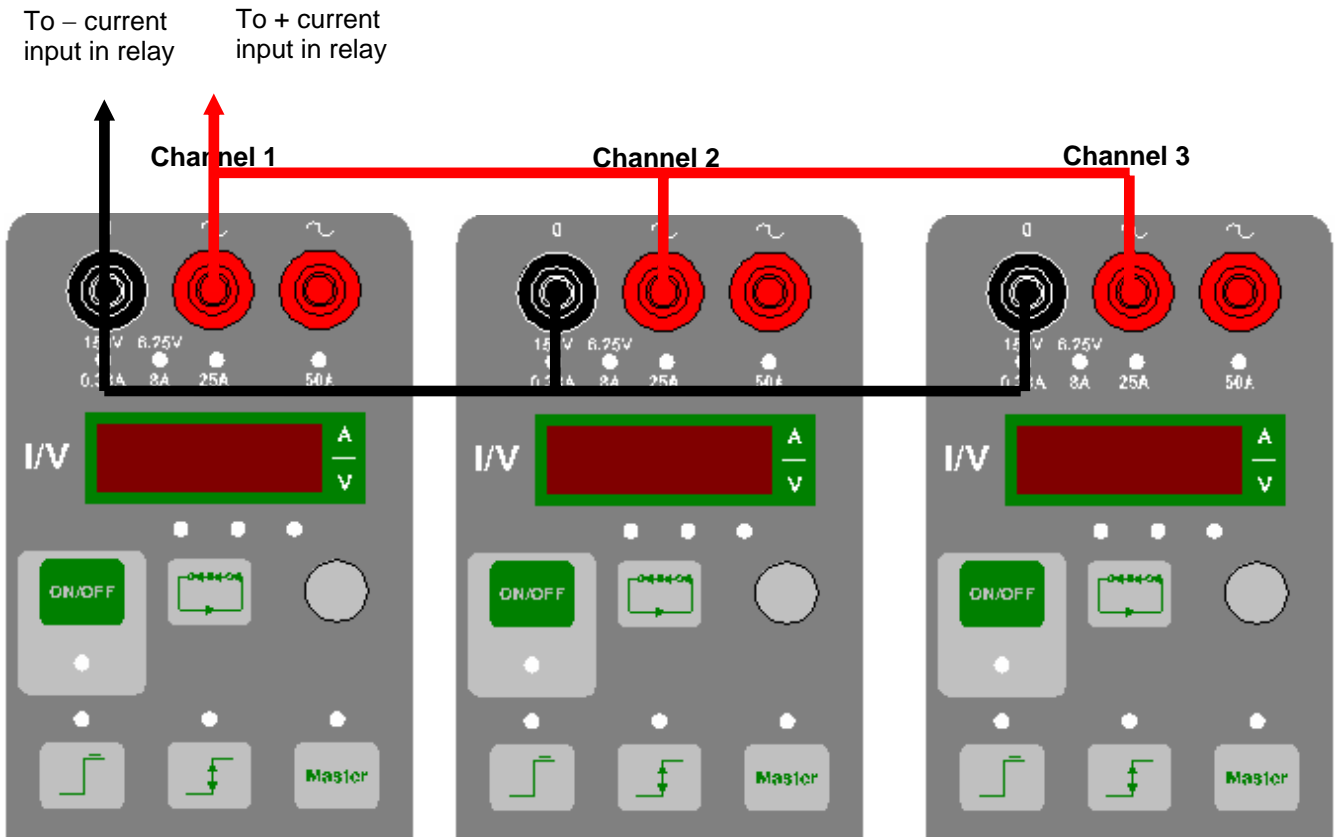
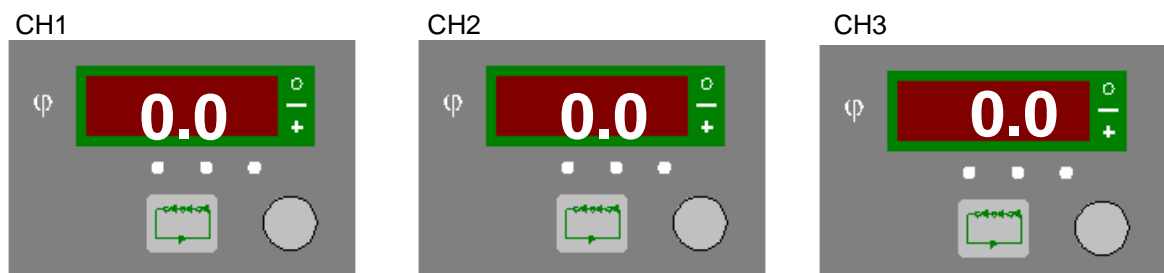

Figure 10: Channels Parallel Connection

Remember that the current outputs, to be added correctly, must have the same phase angle, for instance:



We can select the same or different levels in the outputs but, to achieve the maximum power, we recommend to use them with the same levels (for instance, if we want to inject 60 A, we would set 20 A in each channel).

To use the three power outputs as one, we will select the *Master-Slave-Slave configuration*, and then we just have to turn the channel 1 output on.

Note: Of course, we can connect only two channels. It will depend on the power output required.

3.4.3. EXAMPLE

Suppose we want to inject 65 A to a relay using the three channels in parallel. After making the connections, we will select:

| | |
|-----------------------------------|-------------------|
| CH ₁ → Amplitude: 22 A | Phase angle: 0.0° |
| CH ₂ → Amplitude: 22 A | Phase angle: 0.0° |
| CH ₃ → Amplitude: 21 A | Phase angle: 0.0° |

Now we can have 300 VA as maximum, so the current we can get from the equipment will depend on the connected load. As we don't know this impedance load of the relay, we will calculate the maximum load that can be connected to the taps injecting 65 A:

$$VA_{\text{OUTPUT}} = I_{\text{OUTPUT}} \times V_{\text{OUTPUT}}$$

$$Z_{\text{LOAD}} = V_{\text{OUTPUT}} / I_{\text{OUTPUT}} \Rightarrow VA_{\text{OUTPUT}} = I_{\text{OUTPUT}}^2 \times Z_{\text{LOAD}}$$

Then if we are looking for the maximum load at 65 A:

$$Z_{\text{MAXIMUM LOAD}} = VA_{\text{MAXIMUM OUTPUT}} / I_{\text{OUTPUT}}^2 = 300/65^2 = 0.071 \Omega$$

If we connect a relay with higher impedance than 0.071 Ω (considering PTE-50-CET as an ideal generator), it will be an overload for the PTE-50-CET. The equipment will stop the injection, indicating the *Overload Alarm*.

3.5. GENERAL CONTROL SECTION

This part of the equipment refers to the general control. The unit contains several necessary controls to perform the following functions:

- Using RS-232.
- SYNCHRONIZE selection.
- HARMONICS selection.
- BOOSTER activation.
- EVENT Output.
- Monitor signals.
- BUS-PTE interconnection.

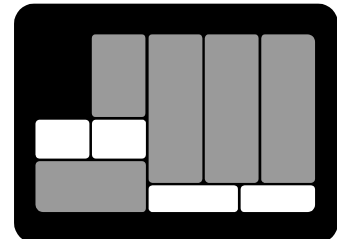

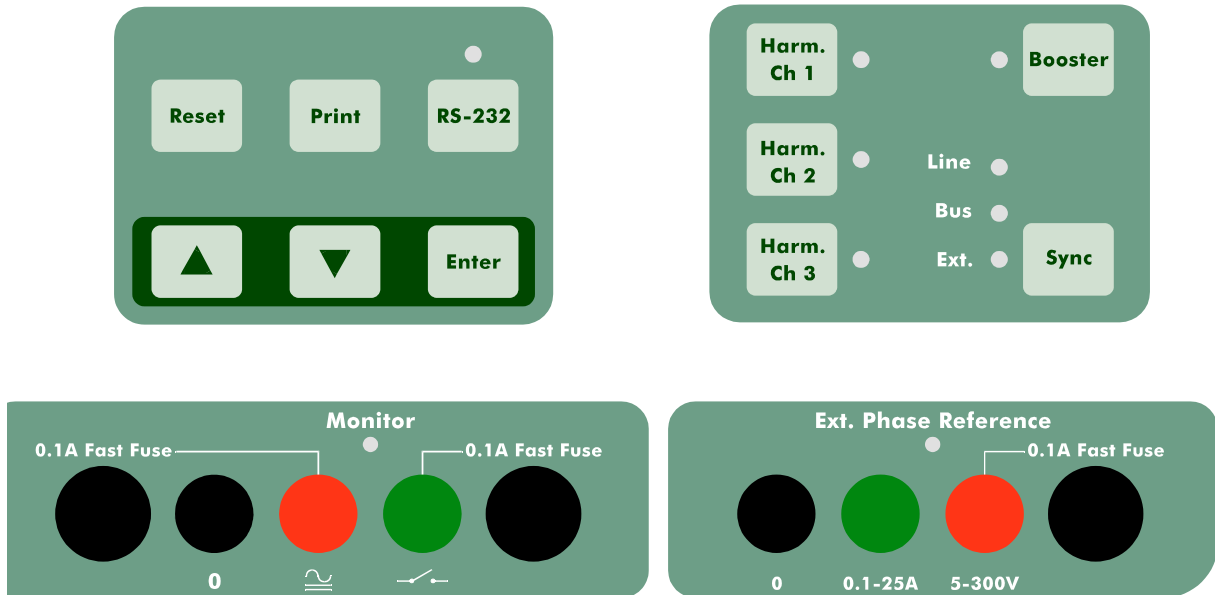

Figure 11: General Control Sections

3.5.1. CONTROL KEYS

3.5.1.1. Reset

Pressing this key a reset in the unit is made, selecting a three phase current system synchronized to the main supply frequency (Line).

3.5.1.2. Print

Pressing this key, if there is a serial input printer connected to the unit, the actual values on the displays will be printed.

3.5.1.3. RS-232 serial port control

RS-232 This press key controls the RS-232 COM port activation to communicate the unit to a PC. The LED above this key indicates this.

3.5.1.4. SYNCHRONIZATION

Sync This key controls the different synchronizing references available in the PTE-50-CET. Each time this key is pressed a different reference is selected. When the desired reference is selected, it is with the objective that, other units can be synchronized to the PTE-50-CET if required. Depending on the Mode selected, the information is sent or not sent to the PTE-BUS.

There are 2 distinct function modes:

INDEPENDENT MODE:

This mode starts by defect when the equipment is turned on and allows synchronizing a reference in 3 ways “Line”, “Bus”, and “Ext”.

The press key works in a sequential way, each time the key is pressed each passes to one the references mentioned. The selected reference is not sent to the PTE-BUS.

MASTER OF REFERENCE MODE:

To activate this mode it necessary to press the key for at least 3 seconds, until a "beep" sound is heard. In this mode allows synchronizing a reference in 2 ways, “Line” and “Ext”.

The press key works in a sequential way, each time the key is pressed each passes to one or the other reference. The selected reference in this case is sent to the PTE-BUS.

To retrun to the normal (INDEPENDENT) mode, press the key again for 3 seconds, until the"beep" sound is heard.

3.5.1.5. HARMONICS selection

**Harm.
Ch 1**

There are 3 keys, one for each output channel, marked CH1, CH2, and CH3 respectively. They allow selecting the harmonics of the fundamental frequency chosen independently in each channel.

**Harm.
Ch 2**

As other press keys, each time one of these keys is pressed the harmonic will change up to the 5th harmonic, so you can select: 1st, 2nd, 3rd, 4th and 5th.

**Harm.
Ch 3**

3.5.1.6. Activating the BOOSTER

Booster

The BOOSTER key has two modes, ACTIVATED and DEACTIVATED. When the unit is turned on is in the DEACTIVATED mode. When it is activated, the maximum voltage is double in each output range. This function is automatically deactivated if it is no necessary.

3.5.2. OPTIC INDICATORS

3.5.2.1. RS-232 port indicator

RS-232



This is a 3 mm LED (red). When it lit, indicates that the serial port RS-232 is active so it can send or receive information.

3.5.2.2. SYNCHRONIZING REFERENCE indicators

They are three, 3 mm, red LED's.

Line ○

Bus ○

Ext. ○ Depending on the function mode selected (INDEPENDENT or MASTER of REFERENCE) functions as follows:

INDEPENDENT MODE:

Only one of the three, 3 mm red LED's, can be on at the same time.

- **Line:** the reference is the main voltage supply.
- **Bus:** the reference is another PTE unit connected via BUS-PTE, normally to the PTE-300-V or PTE-100-V. If the led is flashing there is no reference in the BUS.
- **Ext:** the selected reference is taken from another instrument or equipment Connected in the external reference tap. If the led is flashing there is no valid Reference.

MASTER of REFERENCE MODE:

The LED marked “**Bus**” will be flashing slowly, indicating that the equipment is in the Master of Reference Mode. The other LED's “**Line**” y “**Ext**” and only one of these can be on at the same time.

- **Line:** The reference of the equipment is taken from the voltage supply and sends this information to the PTE-BUS, therefore the other equipment connected to the BUS will also be reference to it.
- **Ext:** The reference of the equipment is taken from the External Reference and sends this information to the PTE-BUS, therefore the other equipment connected to the BUS will also be reference to it. If the led is flashing there is no valid Reference.

3.5.2.3. Monitor state indicator

This is a 3 mm red LED, located above the *Monitor* taps. When it is on, indicates that the *Monitor* is ACTIVATED. When it is off, indicates the *Monitor* is DEACTIVATED.

3.5.3. CONNECTORS AND FUSES

3.5.3.1. Voltage supply

PTE-50-CET has channel fuses that protects the *Power Module* of each channel. These fuses can be broken in different circumstances (like high transients in the outputs).

When this happens, one of the power outputs half-cycle is lost. That's why the values you check in you ammeter differ from the ones displayed in the equipment.

To repair it you just must do the following:

1. Disconnect the main supply.
2. Open carefully the *Front Panel*: extract the six screws and take care of no disconnecting any other cables inside the equipment.
3. The channel fuses are located under the *Main Voltage Supply Section*:

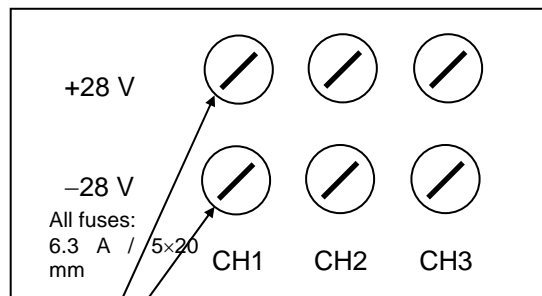

Figure 12: *Fuses Box*

4. Check the correspondent fuses of the channel (CH₁, for instance) and change the broken one. The fuses are 6.3 A (fast type) and were delivered with the equipment
5. Close carefully the *Front Panel*.
6. Connect the main supply and test again the channel outputs.

When you want to test the equipment outputs, remember that below 3% of the tap, there is no feedback (neither in amplitude nor in phase angle), so you can get errors. Then you must perform this kind of test with values over 3% of the chosen tap

3.5.3.2. Monitor input taps

These taps are located in the lower right hand part of the unit and consist of three, 4 mm female connectors. These taps receive the input signals to the unit.

- Black tap (0): this is the common tap.
- Red tap: any DC or AC voltage between 5 and 250 V can be connected between the common tap (0) and this one. The presence of voltage will activate the *Monitor*.
- Green tap: between this tap and the common a DRY CONTACT can be connected. A close contact will activate the *Monitor*.

Both inputs are protected by fuses, fast characteristic, 0.1 A..

The *Monitor* signal fuses are situated to the left and to the right of the monitor taps. The fuse on the left protects the voltage-input tap and the fuse on the right protects the free contact input tap. To remove the fuse, turn the cap anti-clockwise. These are fast fuses, 5x20 mm, 0.1 A.

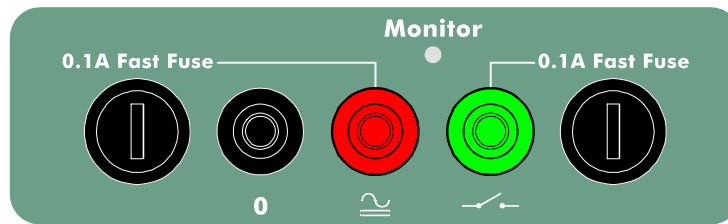

Figure 13: Signal Monitor

3.5.3.3. Auxiliary output to start an external timer



This is a BNC connector that delivers a “close contact” signal of 20 ms duration, with the main objective to start an external timer. This output will be active each time one of the following occurs:

- When the ON/OFF key of the unit is pressed, activating or deactivating the power output.
- When the *Step to 2nd Value* key is pressed, either in level or in phase.

3.5.3.4. RS-232 connector

This communication connector serial port RS-232 is a CANON connector of 9 pins, located in the upper left part of the unit. Its pin out is as follows:

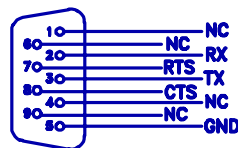

Where:

RS-232

| | |
|-----|------------------------|
| NC | Not connected |
| GND | Earth ground |
| RX | Input DATA |
| TX | Transmission DATA |
| RTS | Output - Send |
| CTS | Input ready to receive |

The unit is supplied with a connecting cable ready to connect directly to this output, to any type of computer or serial input printer.

4. FUNCTIONS: USE AND DESCRIPTIONS

Throughout this section a detailed description of the use and procedures for the PTE-50-CET will be given. This unit has been designed to be used as a portable three-phase unit to test any kind of relays, as a stand-alone unit or interconnected to other auxiliary units. All the functions that are incorporated in this unit were designed to easily test the relays. This is achieved, as all functions are located on the front panel in a MANUAL mode, which before required test units, which were programmable by an external computer.

Furthermore, the PTE-50-CET, and thanks to the BUS-PTE, can be easily interconnected to other units in the PTE range, making the specific functions for relay testing, much more simple and effective.

4.1. TIME MEASUREMENT

The timer is normally activated by a power output, despite it is current or voltage. For this reason, when it is stopped by a "STOP" signal, it holds the actual measurement in the display.

The resolution of this timer is 0.001 s, which is sufficient to test almost any protection relay.

4.1.1. SIGNAL MONITOR

It is here where the timer receives the signals from the relay being tested and this is shown in the optic LED indicator marked MONITOR.

The *Signal Monitor* is ACTIVATED in the following conditions:

1. When there is a VOLTAGE PRESENCE between the common tap and the voltage tap (red). This voltage can be between 3 to 250 V in ac or dc. This input is protected with a fuse clearly marked.
2. When there is a CLOSED FREE CONTACT between the common tap and the contact tap (green). This input is protected with a fuse clearly marked on the front panel.

In both of these conditions, when the *Signal Monitor* is active a red LED will light up.

NOTE: When connecting the monitor signal to the free contact tap (green) be sure that it is really free from voltage as the protection fuse will break immediately.

4.1.2. TIMER MODE SELECTION

The timer mode is selected with the *Mode* key and the following modes can be selected

- Mode 1:
 - Start: By the injection of current or voltage.
 - Stop: When the *Signal Monitor* is activated.
- Mode 2:
 - Start: By the injection of current or voltage.

Stop: When the *Signal Monitor* is deactivated.

- Mode 3:

Start: By output disconnection.

Stop: When the *Signal Monitor* is activated.

- Mode 4:

Start: By output disconnection.

Stop: When the *Signal Monitor* is deactivated.

- Mode 5: **Positive Pulse. (Only EXT. Mode)**

Start: When the *Signal Monitor* is activated.

Stop: When the *Signal Monitor* is deactivated.

- Mode 6: **Negative Pulse (Only EXT. Mode)**

Start: When the *Signal Monitor* is deactivated.

Stop: When the *Signal Monitor* is activated.

The different modes are indicated by their corresponding optic LEDs.

If a mode is changed while the timer is operating the test must be repeated.

4.2. LEVEL SECTION: POWER OUTPUT

This section describes the correct use of the PTE-50-CET power outputs. The output can be selected in current up to 50 A or in voltage up to 150 V. The power outputs can be synchronized to three available references as it is explained in this section, as well. Because the three output channels are similar, only one will be explained.

4.2.1. INITIAL STATUS

When the unit is turned on, the following values and selections are made:

1. Output mode: current.
2. Selected range: 25 A.
3. Selected value: 00.00 A.
4. Output status: OFF.
5. Reference: Line.

4.2.2. OUTPUT MODE SELECTION (I/V)

As mentioned before, the PTE-50-CET can be used as a current or voltage source. When the unit is turned on it will be in the current mode. The voltage output is achieved in the following way:

Press the *TAP I/V* key for more than 2 seconds. The display will change its units to V (Volts) and the output range will automatically change to 6.25V. The values selected from now on will be in volts.

To return to the current mode press the same key again for more than 2 seconds.

4.2.3. OUTPUT RANGE SELECTION

The following output ranges are available:

- Current mode: 0.33 / 8 / 25 / 50 A.
- Voltage mode: 6.25 / 150 V.

To select any of these ranges press the *TAP I/V* key. The display will automatically change. In case we have selected a value and this is greater than the new selected range, the value will set to the maximum value in the selected range.

The active range is that which has its corresponding LED lit.

NOTE: To change to the 50 A range, you must do the same, but you have to connect the cables to the 50 A taps. In case you have changed to this 50 A range and the cables remain in the 25 A taps, the actual values injected to the relay will be half the displayed values.

4.2.4. REFERENCE SOURCE SELECTION

When the unit is turned on, it is synchronized to the MAIN VOLTAGE SUPPLY. This is indicated with the LINE LED on. If you want to change this reference you must do the following:

1. Press the SYNC key. The unit will pass to the reference BUS-PTE, which is indicated by the corresponding LED marked BUS. This implies that the reference is the BUS-PTE, with any other unit of the PTE range. If the units are not interconnected (BUS-PTE is not connected or there is no *Reference Master* selected) the LED indicator will flash slowly indicating that there is no reference. If there is no reference in the BUS and the output is turned on, the unit will synchronize automatically to the last valid reference (LINE).
2. Press again the SYNC key. The unit will pass to *External Reference*, which is indicated by the corresponding LED marked EXT. This implies that the reference is now the signal connected to the *External Phase Reference Input*, introduced in the taps *Ext. Phase Reference*. If there is no signal in these taps the LED EXT will flash slowly indicating that there is no reference or that it is not suitable.

If there is no reference and the output is turned ON, it will synchronize to the last valid reference. The same occurs if there is a valid external reference and it disappears.

3. Press again the SYNC key. The unit will pass to the LINE reference, which is indicated by the corresponding LED marked LINE. This implies that the reference is the main voltage supply.

These changes can be made while the output is ON.

4.2.5. OUTPUT VALUES SELECTION

This is achieved by turning the rotating knob and the digit selector key. The actual value selected is shown on the display, whether the output is ON or OFF. The selected value shown in the display

remains the same when the output is ON. If the value selected is higher than allowed in the range chosen, the rotating knobs continues turning, but the value cannot be increased.

The unit **does not feedback values less than 3 % of the end of the selected range**. In this case the phase and the magnitude values cannot be guaranteed. The following table clarifies this:

| Selected range | 3% of range not feedback | Feedback |
|----------------|--------------------------|----------------|
| 0.33 A | 0 - 0.01 A | 0.01 - 0.33 A |
| 8 A | 0 - 0.24 A | 0.24 - 8 A |
| 25 A | 0 - 0.75 A | 0.75 - 25A |
| 50 A | 0 - 1.5 A | 1.5 - 50 A |
| 150 V | 0 - 4.5 V | 4.5 - 150 V |
| 6.25 V | 0 - 0.187 V | 0.187 - 6.25 V |

In this case, if you increase the level with the output ON, overload alarms may be produced, due to transitories, disconnecting the corresponding channel.

4.2.6. OUTPUT CONTROL: ON/OFF AND ALARMS

The power output status is controlled by the ON/OFF key, and is active when the corresponding LED is lit. To turn off this output simply press the key again.

This output is protected by 2 types of electronic protection, which are indicated by the corresponding LEDs marked, OVERLOAD (OVL) and/or THERMAL (TH).



When either of these are active (lit), the power output is immediately turned off and the LED ON/OFF will turn off.

When the overload alarm is lit, it is due to an overload of the maximum power values allowed in the output. In some cases it may be due to fast transitories that the unit cannot feedback properly, such as a sudden step from a very low output value to another one very high. To start again, simply press the output key ON to activate the output. If the cause of this overload has been rectified the unit will function as normal, if the overload remains the unit will turn off again.

When the thermal alarm is lit, it is because the internal temperature has reached the allowable limit. When this occurs, you must turn off the unit. When this alarm LED is lit, the unit cannot be used, and there will be no output. When the unit has cooled down to a lower temperature the LED will go off and the unit can be used.

4.2.7. DYNAMIC TESTS: STEP TO 2ND VALUE

The PTE-50-CET allows the operator to make dynamic tests, by allowing jumps (steps) from one value to another, whether it is from higher to lower or vice versa. This is very useful, for example, when performing dynamic characteristic tests. This is achieved as follows:

1. Press the key . In the display will appear the reading "0000" or the 2nd value previously recorded. Select with the rotating knob the desired value to acts as 2nd value.
2. Press again the key . The display will show the actual value that is the 1st value. Turn on the output if this is off.

3. Press the key . This will produce instantaneously the step from the actual value to the 2nd selected value. At the same time there is a signal sent to *Start Chrono* output, to start an external timer if desired. Furthermore, the LED located above this press key indicates that the 2nd value is in the output. **IMPORTANT: When the unit is in this situation the displayed value cannot be changed even if the rotating knobs are turned.**

When this key  is pressed again, the step will be the opposite, that is from the 2nd value to the 1st one. At the same time, there is a signal sent to *Start Chrono* output. The LED will go off indicating the output is at the 1st value.

NOTA: You can select a 2nd value even when the corresponding output is on. In this situation, though the display is not showing the actual output value, this remains in the output.

4.3. PHASE ANGLE SELECTION

This section describes in detail the use of the phase shifter incorporated in the PTE-50-CET, as well as the *External Phase and Frequency Reference*.

The display in this section is indicated in degrees (0-359.9) between the output and the reference choose (Freq. Ext., Line, Bus) in a ANTI-CLOCKWISE sense as follows

4.3.1. PHASE ANGLE SENSE

PTE-50-CET allows two phase angle senses: AMERICAN or EUROPEAN (ordered by the client). Whatever it is selected, the initial unit status will be a balanced three phase system, turning ANTI-CLOCKWISE.

a) EUROPEAN SENSE:

The display shows, in sexagesimal degrees (0-359.9), the phase angle between the OUTPUT and the selected reference source (Freq., EXT, LINE and BUS), considered positive when this is ANTI-CLOCKWISE, that is:

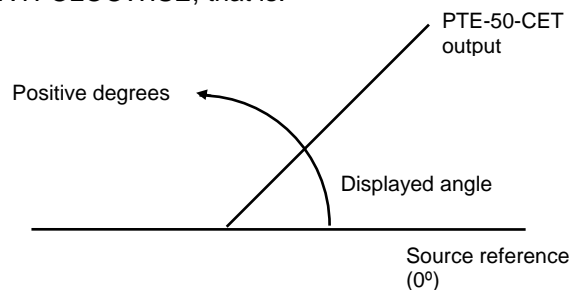

Figure 14: *Phase Angle Selection (European)*

When the unit is turned on, the phase angle selection sets the following default states and values:

1. Selected value in channel 1 (CH1): 000.0°
2. Selected value in channel 2 (CH2): 240.0°
3. Selected value in channel 3 (CH3): 120.0°

b) AMERICAN SENSE:

The display shows, in sexagesimal degrees (0-359.9), the phase angle between the OUTPUT and the selected reference source (Freq., EXT, LINE and BUS), considered positive when this is CLOCWISE, that is:

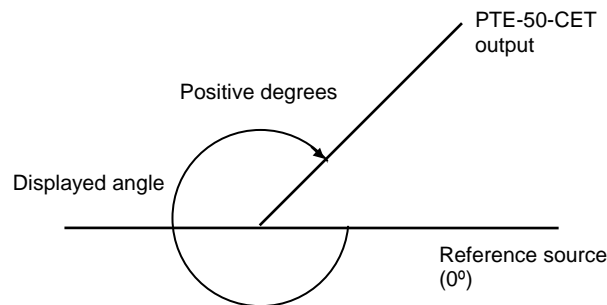





Figure 15: Phase Angle Selection (American)

When the unit is turned on, the phase angle selection sets the following default states and values:

1. Selected value in channel 1 (CH1): 000.0°
2. Selected value in channel 2 (CH2): 120.0°
3. Selected value in channel 3 (CH3): 240.0°

4.3.2. DYNAMIC TESTS: STEP TO 2ND VALUE

The PTE-50-CET allows the operator to make dynamic tests, by allowing jumps (steps) from one value to another, whether it is from higher to lower or vice versa. This is very useful, for example, when testing out-of-step generator protective relays. This is achieved as follows:

1. Press the key . In the display will appear the reading "0000" or the 2nd value previously recorded. Select with the rotating knob the desired value to acts as 2nd value.
2. Press again the key . The display will show the actual value that is the 1st value. Turn on the output if this is off.
3. Press the key . This will produce instantaneously the step from the actual value to the 2nd selected value. At the same time there is a signal sent to *Start Chrono* output, to start an external timer if desired. Furthermore, the LED located above this press key indicates that the 2nd value is in the output. **IMPORTANT: When the unit is in this situation the displayed phase angle cannot be changed even if the rotating knobs are turned.**



When this key is pressed again, the step will be the opposite, that is from the 2nd value to the 1st one. At the same time, there is a signal sent to *Start Chrono* output. The LED will go off indicating the output is at the 1st value.

NOTA: You can select a 2nd value even when the corresponding output is on. In this situation, though the display is not showing the actual output value, this remains in the output.

4.3.3. USE OF EXTERNAL REFERENCE INPUT

The *External Reference* input admits two types of signal: current (from 0.1 A up to 25 A) or voltage (from 5 V up to 300 V), with frequencies between 40 and 70 Hz. This input is very useful as it allows the unit to work in a differential mode respect to the signal inputs. Because of the wide range of input values in both voltage and current, it is capable to work with various types of supply generators for a signal reference.

The current input should be connected to the black tap marked "0" and the green tap marked 0.1 - 25 A. The voltage input should be connected to the black tap marked "0" and the red tap marked 5 - 300 V.

IMPORTANT NOTE: The current input has low impedance SHUNT detector. NEVER connect a voltage signal to this tap, as it is equivalent to short-circuit. It may cause serious damage to the external voltage supply if it is not protected.

When *External Reference* is selected as reference source in the unit (Ext.), if it is valid, the LED located to the left hand of (0) tap will light up.

In case this reference signal is not proper, the unit will be synchronized to the last valid reference.

4.4. GENERAL CONTROL SECTION

The general control section is intended to acts as an interface between the unit and other PTE units, extern printer, computer, and detects the answer from the under testing relay through the Signal Monitor. All these functions are described below.

4.4.1. SIGNAL MONITOR

It is designed to receive the signals from the relay being tested and the status is shown in the LED indicator marked "MONITOR".

The *Signal Monitor* is activated (LED monitor lights up) in one of the following conditions:

1. When there is a voltage between the common tap (black) and the voltage tap (red). This voltage can be between 5 to 250 V, ac or dc. This input tap is protected with a fuse clearly marked on the front panel.
2. When there is a closed, voltage free, contact between the common tap (black) and the contact tap (green). This input tap is protected with a fuse clearly marked on the front panel.

NOTE: Be sure that, when connecting a signal to the green tap, it is voltage free. If not, the protection fuse will break immediately.

4.5. COMMUNICATION IN BUS-PTE

4.5.1. EVENTS IN BUS-PTE

The PTE range equipment has been designed in such a way that the test equipments can be interconnected via the BUS-PTE connector, thus forming a stronger system when testing. The equipment not only can receive commands by software, but can also send information about its own status through determined signals, called EVENTS. Activation and deactivation of the *Signal Monitor*, *Output On or Off*, a *Step to 2nd Value* in amplitude and/or Phase, etc., are some examples of these mentioned EVENTS

In a PTE-50-CET, these events can be:

- a) Positive events:
 - Monitor active in a PTE equipment.
 - Output active in a PTE equipment.
 - An output value step to a second level, higher in value that the first one.
 - Phase angle step to a second level, higher in value that the first one.
- b) Negative events:
 - Monitor becomes non-active in a PTE equipment.
 - Equipment output is cut off.
 - An output value step to a second level, lower in value that the first one.
 - Phase angle step to a second level, lower in value that the first one.

In any case, the documentation supplied with a PTE equipment, gives information about the particular events transmitted to the BUS-PTE by the particular unit.

4.5.2. EVENT TRANSMITTED BY A PTE-50-CET

A PTE-50-CET sends to the BUS-PTE the following events:

- a) Positive events:
 - Output ON.
 - *Step to 2nd Value* (voltage/current), higher than the actual.

- *Step to 2nd Value* (phase angle), higher than the actual.
- *Signal Monitor* active.

b) Negative events:

- Output OFF.
- *Step to 2nd Value* (voltage/current), lower than the actual.
- *Step to 2nd Value* (phase angle), lower than the actual.
- *Signal Monitor* active

4.6. SPECIAL FUNCTIONS

4.6.1. AUTO OFF

In case this function is selected, the output channels ON will be automatically turned off when the *Signal Monitor* is activated (For instance: relay trip).

PTE-50-CET has this function selected by default. To activate or deactivate it, you must do the following:

1. Press for 2 s *Enter* key located between the *Print* and *RS-232* keys. The following readings will appear in the displays:

| CH1 | CH2 | CH3 |
|------|------|-----|
| FUnC | Auto | oFF |
| EnAb | | |

2. To activate or deactivate the function, press again the *Enter* key, emerging in the phase angle display of CH1: **EnAb** (enable) o **diSA** (disable).
3. Once the selection is made, press again the *Enter* key for 2 seconds to leave the selection.

4.6.2. FAILURES DETECTION

The PTE-50-CET incorporates a self-check function that is active every time the unit is turned ON. If a failure is detected in one or more of the controlled parameters, a message appears in the displays in the following manner:

| ABCD⇒ Level Display EFGH⇒ Phase Display | | | | | | | | |
|--|----------|---------------------|-------------------|-----------------------|-------------------|-----------------|------------------|------------------|
| | A | B | C | D | E | F | G | H |
| 0 | Always 0 | No error | No error | No error | No error | No error | No error | No error |
| 1 | | LINE failure | RadF temp. | --- | +12VA high | +5V high | +12V high | +28V high |
| 2 | | 6'25 fuse | Int temp. | PIIClk failure | +12VA low | +5V low | +12V low | +28V low |
| 3 | | 1+2 | 1+2 | --- | +12VA null | +5V null | +12V null | +28V null |
| 4 | | 150 fuse | OVL | Trf temp. | -12VA high | No error | -12V high | -28V high |
| 5 | | 1+4 | 1+4 | --- | 1+4 | +5V high | 1+4 | 1+4 |
| 6 | | 2+4 | 2+4 | 2+4 | 2+4 | +5V low | 2+4 | 2+4 |
| 7 | | 1+2+4 | 1+2+4 | --- | 3+4 | +5V null | 3+4 | 3+4 |
| 8 | | 300 fuse | OVL | RadA temp. | -12VA low | No error | -12V low | -28V low |
| 9 | | 1+8 | 1+8 | --- | 1+8 | +5V high | 1+8 | 1+8 |
| A | | 2+8 | 2+8 | 2+8 | 2+8 | +5V low | 2+8 | 2+8 |
| B | | 1+2+8 | 1+2+8 | --- | 3+8 | +5V null | 3+8 | 3+8 |
| C | | 4+8 | 4+8 | 4+8 | -12VA null | No error | -12V null | -28V null |
| D | | 1+4+8 | 1+4+8 | --- | 1+C | +5V high | 1+C | 1+C |
| E | | 2+4+8 | 2+4+8 | 2+4+8 | 2+C | +5V low | 2+C | 2+C |
| F | | 1+2+4+8 | 1+2+4+8 | --- | 3+C | +5V null | 3+C | 3+C |

Notes:

---: This code will never be shown.

xxx: Basic error code.

1+2: This code must be interpreted as the occurrence of basic errors 1 and 2 simultaneously.

5. SPECIFICATIONS

PTE-50-CET contains the following outputs and features:

- Three independent power outputs up to 50 A in current mode and 150 V in voltage mode, with angle phase regulation between 0° and 360°.
- Timer, 1 ms resolution, with different options to start and stop the time measurement.
- Harmonics generator, independent in each channel, up to the 5th harmonic.

5.1. POWER GENERATORS

a) Three independent power outputs up to 50 A in current mode and 150 V in voltage mode, with angle phase regulation between 0° and 360°. They have the following technical characteristics:

- Amplitude indicator: 4 digits display LED.
- Available ranges:
 - Current Mode: 0 - 0.330 A Regulation resolution: 0.001 / 0.01 / 0.1 A
 - 0 - 8.000 A Regulation resolution: 0.001 / 0.01 / 0.1 A
 - 0 - 25.00 A Regulation resolution: 0.01 / 0.1 / 1 A
 - 0 - 50.00 A Regulation resolution: 0.01 / 0.1 / 1 A
 - Voltage Mode: 0 - 6.250 V Regulation resolution: 0.001 / 0.01 / 0.1 V
 - 0 - 150.0 V Regulation resolution: 0.1 / 1 / 10 V
- Accuracy: better than 1 % of the selected value between 10 % and 100 % of the selected range.
- Power: 100 VA continuously.
- Protection: overload and thermal.
- Output mode: floating, completely isolated of the rest and the ground.
- Output distortion:
 - Typical: < 0.5 %
 - Maximum: 1 %
- Phase angle regulation: 0 - 359.9°.
- Phase angle regulation resolution:
 - Selectable between: 0.1 / 1 / 10 °.
 - Accuracy: ± 0.5° of the selected value.

b) The following functions are available, per channel, through suitable front panel controls:

- Selection of 2nd value (fault value while the actual value remains in the output).
- Push-button to step to the above value mentioned.

- This feature exists for amplitudes and phase angles, independent or linked.

- c) One of the output channels is available to be configured as *Master* of the other two, that can be configured as *Slave* or *Independent*. Every change made in the *Master* channel will be effective in the *Slave* channels, at all levels.

5.2. INTERNAL TIMER

The unit has a **digital** built-in timer with the following technical characteristics:

- Indication display: 5 digit LED type.
- Available ranges (autorange):
 - 00.001 a 99.999 s
 - 100.00 a 999.99 s
 - 1000.0 a 9999.9 s
 - 10000 a 99999 s
- Resolution: 0.001 s
- Accuracy: ± 0.02 % of the value displayed ± 0.001 s
- Operation modes:
 - START by:
 - a) Internal signal:
 - Any output ON/OFF.
 - Any step or change to 2nd value.
 - b) External signal:
 - Normally open contact in the monitor.
 - Normally close contact in the monitor.
 - STOP by: Any external signal in the monitor, normally open, normally close, dry contact, or by voltage applied or voltage removed.
- Duration measurement: Duration of positive and negative signals in the monitor is available.

5.3. HARMONICS GENERATOR

The unit has the possibility to select, from the front panel controls, up to the 5th harmonic of the fundamental reference frequency on each output channel, in a completely independent way one of each other, despite it is in current or voltage mode.

5.4. EXTERNAL REFERENCE INPUT

The unit has available an external reference input, capable to receive voltage or current signals, from any external source, in the following ranges:

- Voltage input: between 5 and 300 V.
- Current input: between 0.1 and 25 A.
- Frequency range: between 40 and 70 Hz.

5.5. SIGNAL MONITORS

The unit has two signal monitors:

- One is available to start the timer from any external dry contact signal.
- Another works with dry contacts and live voltage signals from 5 to 250 V ac. o dc to stop the timer.

5.6. AVAILABLE REFERENCES

The equipment power output has the possibility to be referenced to the following synchronizing sources:

- Communication BUS.
- Voltage Supply of the unit.
- External Reference Input.

5.7. CONTAINER

The unit is contained in aluminum case that, when closed, offers an IP-65 protection.

6. TECHNICAL ASSISTANCE, AFTER SALES SERVICE AND WARRANTY

6.1. WARRANTY

Our warranty expresses the confidence we have in our products, based on the reliability and functions that are expected by our clients.

The warranty covers the repairs and/or replacements of components, which are faulty without costs.

The software designed by EUROSMC, either installed in the product or in the computer, is guaranteed of programming instruction failures.

Period: All products made by EUROSMC are guaranteed for a period of one year from the date and/or day reflected in the warranty, which is included with the unit.

EUROSMC will repair or replace any abnormal function or defects in our product that were not provoked by the following, which may cause the warranty to be revoked:

- Improper use of the product, incorrect connections or operations not specified or explained in this *Instruction Manual*.
- Any manipulation of the product, repairs, adjustments, or changes, made by unauthorized persons.
- The use of the product outside its specifications.

6.2. AFTER SALES SUPPORT

EUROSMC offers the supply of materials and components in all our products for 3 years after the product is no longer manufactured. We offer our technical support for a 5-year period.

6.3. OTHER EUROSMC PRODUCTS

For more information of our product range, please consult our local representative or us. Generally we manufacture the following:

- Relay testing equipment for voltage, current, frequency and synchronizing relays.
- Portable timers.
- Alternating current test equipment.
- Current supplies.
- Systems to test MCB's.
- Voltage and current regulation equipment.